



# MD6 Series 2D Barcode Scanner

## User Manual



Version: MD6\_UM\_EN\_V1.1.9



**Warning:** Ensure that the optional DC adapter works at +5V, especially for the RS-232 interface cable.

NOTICE:

1. All software, including firmware, furnished to the user is on a licensed basis.
2. The right is reserved to make changes to any software or product to improve reliability, function, or design.
3. The material in this manual is subject to change without notice.
4. A standard packing includes a scanner, a USB cable and a CD (or a user manual). Accessories include a stand, a RS-232 cable, a 5V adaptor and a PS2 cable.



# Contents

Technical specifications .....	1
Cable connector pin-outs descriptions.....	2
Default setting for each barcode.....	3
Dimensions .....	5
Parts of the scanner .....	6
Introduction to installation.....	7
Programming instruction.....	9
Operate the scanner by receiving command via UART.....	10
Interface selection.....	11
Keyboard wedge interface.....	12
RS-232 interface .....	16
USB interface.....	18
Hand-held scan & some global settings.....	20
Indication.....	23
Decode illumination and decode aiming pattern.....	24
DPM, Multiple symbols, Structured append, etc. read setting.....	25
UPC-A.....	29
UPC-E.....	31
UPC-E1 .....	33
EAN-13 (ISBN/ISSN).....	35
EAN-8 .....	37
Code 39 (Code 32, Trioptic Code 39).....	39
Interleaved 2 of 5 .....	42
Industrial 2 of 5.....	44
Matrix 2 of 5 .....	45
Codabar.....	46
Code 128.....	48
UCC/EAN 128 .....	50
ISBT 128 .....	52
Code 93.....	53
Code 11.....	54
MSI/Plessey.....	56

UK/Plessey.....	58
China Post.....	59
GS1 DataBar (GS1 DataBar Truncated).....	60
GS1 DataBar Limited .....	61
GS1 DataBar Expanded .....	62
China Finance .....	63
PDF417 .....	65
MicroPDF417.....	66
QR Code .....	67
Data Matrix.....	68
Han Xin Code .....	69
Aztec Code.....	70
G1-G6 & C1-C2 & FN1 substitution string setting.....	71
G1-G4 string position & Code ID position .....	75
String transmission .....	76
Test Chart.....	79
ASCII Table.....	84
Barcode representing non-printable character .....	85
Return default parameters & others.....	86
Configuration alphanumeric entry barcode.....	87

# Technical specifications

Table 1-1 Technical specifications

<b>Input voltage</b>	5 VDC $\pm$ 0.25V
<b>Power</b>	1.60W (working); 0.40W (standby)
<b>Current</b>	320mA (working); 80mA (standby)
<b>Image size</b>	838 $\times$ 640 pixels
<b>Scanning angle</b>	$\pm$ 60°, $\pm$ 40°, $\pm$ 42° (Skew, Pitch, Roll)
<b>Decode capability</b>	1D: UPC-A, UPC-E, UPC-E1, EAN-13, EAN-8, ISBN (Bookland EAN), ISSN, Code 39, Code 39 full ASCII, Code 32, Trioptic Code 39, Interleaved 2 of 5, Industrial 2 of 5, Matrix 2 of 5, Codabar (NW7), Code 128, UCC/EAN 128, ISBT 128, Code 93, Code 11 (USD-8), MSI/Plessey, UK/Plessey, China Post, China Finance, GS1 DataBar (formerly RSS) variants
	2D: PDF417, MicroPDF417, QR Code, DataMatrix, Han Xin Code, Aztec Code
<b>Indicator</b>	Beeper, LED
<b>Interface supported</b>	Keyboard wedge, RS-232, USB Keyboard, USB virtual COM
<b>Operating mode</b>	Hand-held
<b>Dimensions</b>	Height $\times$ Width $\times$ Depth: 178mm $\times$ 69mm $\times$ 82mm
<b>Weight</b>	156g, without cable
<b>Cable</b>	Straight 2.0m
<b>Connector type</b>	RJ-45 phone jack connector
<b>Case material</b>	PC+TPU
<b>Temperature</b>	0° to 50°C (32° to 120°F), Operating; -40° to 60°C (-40° to 140°F), Storage
<b>Humidity</b>	5% to 95% (non-condensing)
<b>Programming method</b>	Manual (reading special barcode)
<b>Program upgrade</b>	Online
<b>Min. element width</b>	3.5mil (HD series), 1 mil = 0.0254mm
<b>Decoding depth</b>	3.5mil Code128 ( 9 chars): 1.5cm – 3.5cm
	5mil Code39 (20 chars): 0.8cm – 5.5cm
	13mil UPC (12 chars): 0.7cm – 16.5cm
	20mil Code39 ( 5 chars): 3.5cm – 21.0cm
	6.7mil PDF417 (20 chars): 0.0cm – 7.5cm
	10 mil DM (20 chars): 0.0cm – 11.5cm
	20 mil QR (20 chars): 0.0cm – 19.5cm
<b>Safety</b>	Laser safety: EN60825-1, Class 1. (For aiming pattern.) EMC: EN 55022, EN 55024 Electrical safety: EN 60950-1 Photobiological safety: EN 62471:2008 Drop resistance: 50+ times of 2.0m (6.6ft) drop to concrete Protection class: IP52

## Cable connector pin-outs descriptions

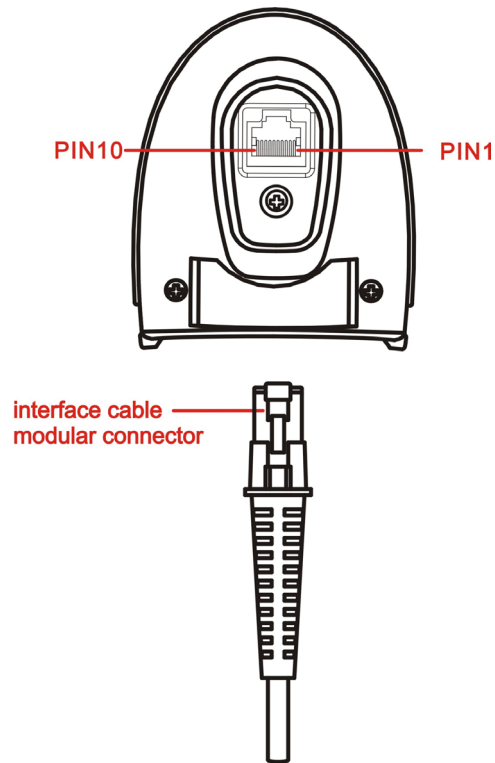

### Cable connector interface pin-outs

The pin-outs descriptions in Table 1 apply to the cable connector on the scanner and are for reference only.

Table 1-2 Cable connector pin-outs descriptions

Pin	RS232	Keyboard (PS2)	USB
1	Power (+5V)	Power (+5V)	Power (+5V)
2	+3.3V ( for interface auto selection purpose)	Ground (for interface auto selection purpose)	+3.3V ( for interface auto selection purpose)
3	Ground	Ground	Ground
4	+3.3V ( for interface auto selection purpose)	Reserved	Ground (for interface auto selection purpose)
5	TxD	KeyClock	Reserved
6	RxD	KeyData	Reserved
7	Reserved	TermClock	Reserved
8	Reserved	TermData	Reserved
9	CTS	Reserved	D-
10	RTS	Reserved	D+

Note: Voltage level of all RS232 Pin-outs (RxD, TxD, CTS and RTS) is 0V for logic low and 3.3V for logic high.



## Default setting for each barcode

Table 2 Default setting for each barcode

Code type	Read enable	Check digit verification	Check digit transmission	Min. code length	Proprietary code ID	AIM code ID
UPC-A	√	√	√	(12) <sup>2</sup>	A	]Em
UPC-E	√	√	√	(8) <sup>2</sup>	D	]Em
UPC-E1	√	√	√	(8) <sup>2</sup>	D	]Em
EAN-13	√	√	√	(13) <sup>2</sup>	A	]Em
EAN-8	√	√	√	(8) <sup>2</sup>	C	]Em
ISBN (Bookland EAN) / ISSN <sup>1</sup>	√	√	√	(13) <sup>2</sup>	B	]Em
Code 39	√	-	-	1	M	]Am
Interleaved 2 of 5	√	-	-	6	I	]Im
Industrial 2 of 5	-	-	-	4	H	]Im
Matrix 2 of 5	√	-	-	6	X	]Im
Codabar	√	-	-	4	N	]Fm
Code 128	√	√	-	1	K	]Cm
UCC/EAN 128	√	√	-	1	K	]Cm
ISBT 128	√	√	-	1	K	]Cm
Code 93	√	√	-	1	L	]Gm
Code 11	-	√	-	4	V	-
MSI/Plessey	-	-	-	4	O	]Mm
UK/Plessey	-	√	-	1	U	]Mm
China Post	√	-	-	(11) <sup>2</sup>	T	]Im
China Finance	√	-	-	(10) <sup>2</sup>	Y	-
GS1 DataBar	√	-	-	(16) <sup>2</sup>	R	]em
GS1 DataBar Truncated <sup>3</sup>	√	-	-	(16) <sup>2</sup>	R	]em
GS1 DataBar Limited	√	-	-	(16) <sup>2</sup>	R	]em
GS1 DataBar Expanded	√	-	-	1	R	]em

<b>Code type</b>	<b>Read enable</b>	<b>Check digit verification</b>	<b>Check digit transmission</b>	<b>Min. code length</b>	<b>Proprietary code ID</b>	<b>AIM code ID</b>
PDF417	√	-	-	-	-	-
MicroPDF417	√	-	-	-	-	-
DataMatrix	√	-	-	-	-	-
QR code	√	-	-	-	-	-
Han Xin Code	√	-	-	-	-	-
Aztec Code	√	-	-	-	-	-

Note: <sup>1</sup>The settings for ISBN/ISSN and EAN-13 must be the same except the code ID.

<sup>2</sup> Fixed-length barcodes.

<sup>3</sup>The settings for GS1 DataBar Truncated and GS1 DataBar must be the same.

# Dimensions

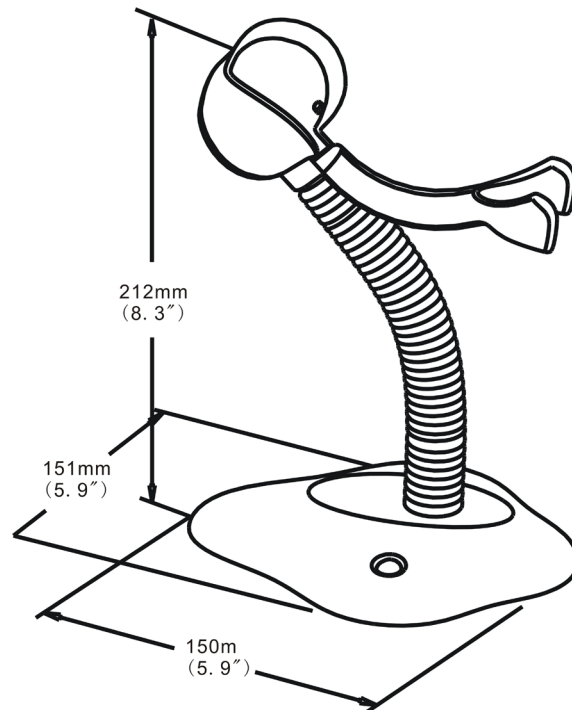
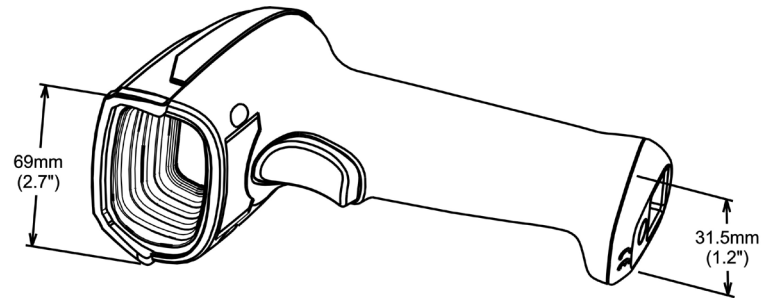
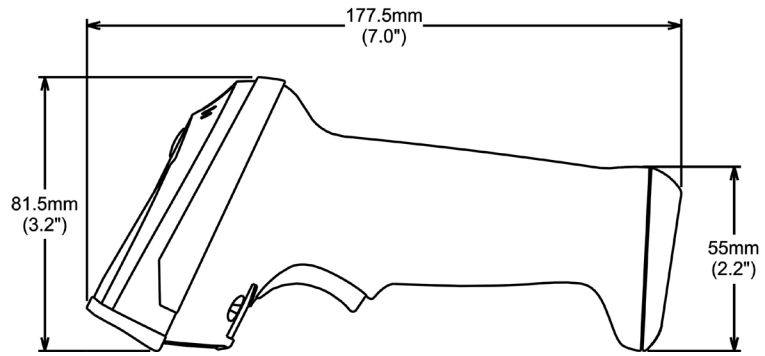

## Parts of the scanner

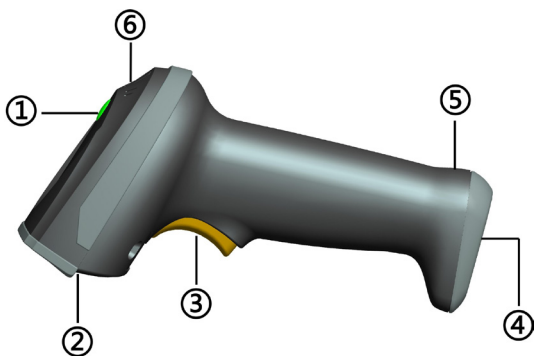

Figure 1

- ① LED
- ② Exit window
- ③ Trigger
- ④ Cable interface port
- ⑤ Release-hole of the cable
- ⑥ Beeper

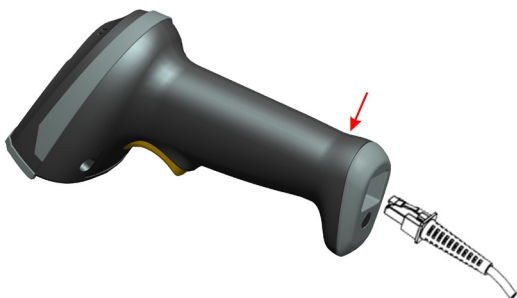

Figure 2

Remove the interface cable:

1. Find the release-hole.
2. Insert a thin wire into the hole and pull out the cable gently.

# Introduction to installation

Note: If any of the below operation is incorrect, turn off the power immediately and check the scanner for any improper connections. Go through all steps again.

## Installation - keyboard wedge

1. Switch off the host and unplug the keyboard connector.
2. Attach the modular connector of the Y-cable to the cable interface port on the scanner.
3. Connect the round male DIN host connector of the Y-cable to the keyboard port on the host device.
4. Connect the round female DIN keyboard connector of the Y-cable to the keyboard.
5. Ensure that all connections are secure.
6. Switch on the host system.

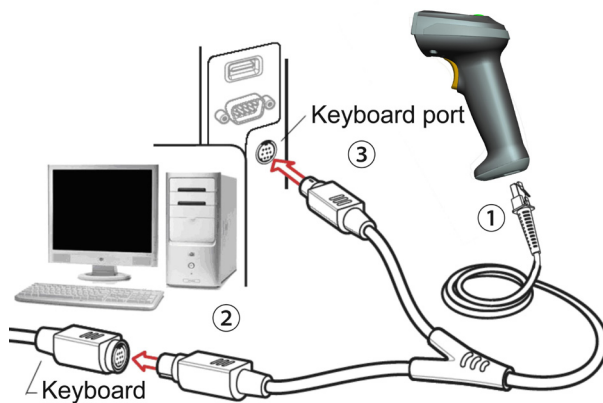

Figure 3

## Installation - RS-232

1. Connect the RS-232 interface cable to the bottom of the scanner.
2. Connect the other end of the interface cable to the serial port on the host. Tighten the two screws to secure the connector to the port.
3. If the host does not have power supply (on PIN 9), connect the external power supply (DC adapter) to the RS-232 cable.

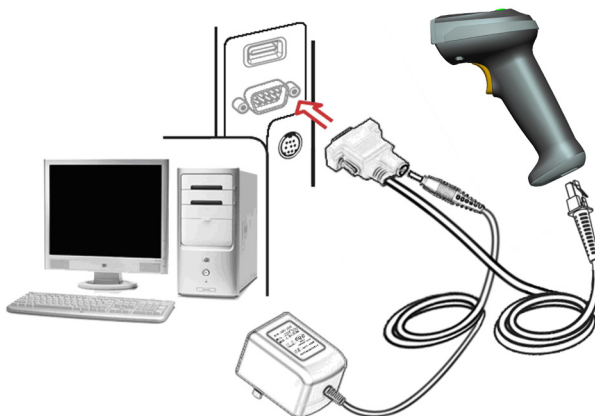

Figure 4

## Installation - USB

The scanner attaches directly to a USB host, and is powered by it. No additional power supply is required.

1. Refer to Figure 5, connect the USB interface cable to the bottom of the scanner.
2. Plug the series A connector in the USB host, or an available port of the terminal.
3. Windows will automatically detect the USB device.

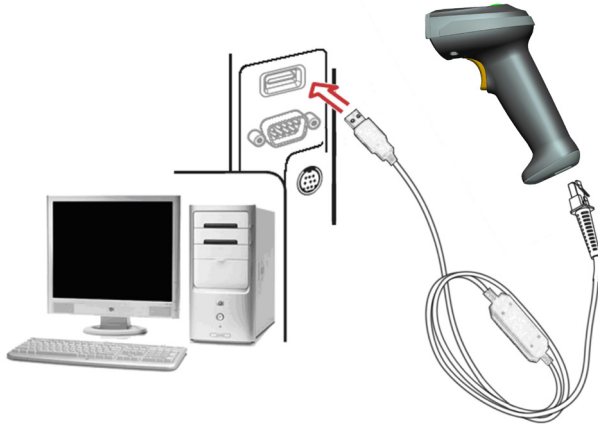

Figure 5

# Programming instruction

## Important notes:

1. During the process of programming, LED is lighting to indicate the programming correctness. LED will go off if any incorrect programming operation performed.
2. After each successful programming, LED will go off and the scanner will beep twice.
3. Throughout the programming bar code menus, the factory default settings are indicated with asterisks (\*).

Two programming modes have been provided as bellows:

### ❶ Single-scan setting

- Scan the appropriate **Single-scan setting** (e.g. **%0101D00%**) according to the user's demand.

**Example:** to set **Flow control** to be XON/XOFF.

**Steps:** Scan the following barcode.



### ❷ Multiple-scan setting

- Step 1. Scan the **Option bar code** barcode (e.g. **%0101M%**) according to the user's demand.
- Step 2. To the right of the option barcode, the necessary alphanumeric inputs are listed. Scan these alphanumeric entries, e.g. **0** ~ **9** , **A** ~ **F** .
- Step 3. Repeat Step 1 to Step 2, if more user parameters input are required.
- Step 4. Scan the **%END%** bar code, listed on the lower left hand corner of each parameter setting part.

**Example:** to set **Flow control** to be XON/XOFF.

**Steps:** Referring to the chapter of "RS-232 interface", scan the following barcodes in order.

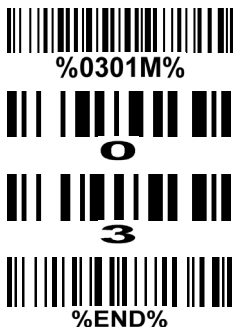

## Operate the scanner by receiving command via UART

*Note:*

- 1- The information in this chapter is provided for the scanner with RS232 cable or USB cable.
- 2- If the scanner is with USB cable, the setting of **USB device type** must be set as "USB virtual COM". Please refer to the chapter of "USB interface".
- 3- Please read the chapter of "Scanning & some global settings" about the setting of **Scanning mode** in details.

*UART parameter should be set as below:*

- (1) Baud rate: 9600 bps;
- (2) Data bits: 8 bits;
- (3) Stop bit: 1 bit;
- (4) Parity check bit: None;
- (5) Flow control: None.

### **Guide of control command: all commands are sent by UART**

- 1) Start command: "0x54" (T)

When the scanner received the above command, it will start barcode scanning following the setting of **Scanning mode**. If the scanner is in the mode of "Auto-detection", the scanner will have a single scan, then returns to "Auto-detection" mode.

- 2) Stop command: "0x50" (P)

If the **Scanning mode** is set as "Alternate continue" or "Continue", and the scanner received the above command, it will stop barcode scanning and act as in an idle mode.

- 3) Restart command: "0x35" (R)

Once the scanner received the above command, it will restart.

### **Returning message from the scanner**

- 1) A successful decode

Once the scanner successfully decoded a barcode, the scanner will stop scanning and returns the barcode data to the Host.

- 2) Not a successful decode

Once the scanner failed to decode a barcode before stopping scanning, the scanner will return a message to the Host. The message is set as "0x25, 0x25, 0x4E, 0x6F, 0x52, 0x65, 0x61, 0x64" (%%NoRead).









## Interface selection

*This scanner supports interfaces such as keyboard wedge, RS-232 serial wedge, and USB interface. In most of the cases, simply selecting an appropriate cable provided by the manufacturer will work for a specific interface.*

### Interface selection:

**Auto detection-** By setting this function, the scanner will automatically detect the keyboard wedge, RS-232 or USB interface for user.

Multiple-scan setting			Single-scan setting
Option bar code	Option	Alpha. entry	
Interface selection  %0101M%	Auto detection (Keyboard wedge /RS-232/USB)	00*	 %0101D00% *
	Keyboard wedge	01	 %0101D01%
	RS-232	02	 %0101D02%
	USB	03	 %0101D03%
 %END%			

## Keyboard wedge interface

**Keyboard type:** As a keyboard interface, the scanner supports most of the popular PCs and IBM terminals.

**Keyboard layout:** The scanner supports different national keyboard layouts.

**Clock period:** According to the PS2 protocol, the clock is provided by the device, e.g. keyboard or scanner, with the period between 60us to 100us.

**Delay-after-compound-key:** In some rare occasions, machine with low speed PS2 communication port would require a free time gap following the press/release of the compound key (Shift, Ctrl or Alt).

**Numeric key:**

**Alphabetic key-** the scanner will output code result as alphabetic key.

**Numeric key-** the scanner will output code result as pressing numeric keypad ( '0', '1', '2', '3', '4', '5', '6', '7', '8', '9', '.', '+', '-', '/', '\*' only).

**Alt+ keypad-** the scanner will output code result as pressing Alt+ numeric key (on keypad). Note that the Num Lock control key must be ON. This setting can be specially adapted for use with different national keyboard layout.

**Power-on simulation:** All of the PCs check the keyboard status during power-on self test. It simulates keyboard timing and passes keyboard present status to the PC during power-on.

**Inter-character delay:** This delay is inserted after each data character transmitted.

**Inter-byte delay:** This delay is inserted after each byte transmitted. Normally a character is comprised of three or above bytes.



















**Block trans. delay:** It is a delay timer between barcode data output. This feature is used to transfer continually with shorter barcode data.

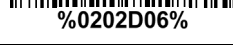
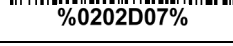
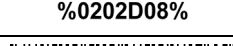
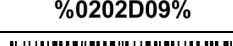
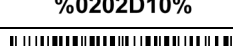
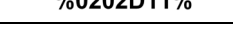







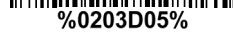

















**Caps Lock reversion:** By setting enable, the status of Caps Lock key (i.e. being pressed ON or OFF) on the keyboard is simulated in a reversion status.





**Caps Lock override:** If this function is enabled, on AT or AT notebook hosts, the keyboard ignores the state of the Caps Lock key. Therefore, an 'A' in the bar code is sent as an 'A' no matter what the state of the keyboard's Caps Lock key.

### A guide of setting while the scanned data is incorrectly displayed on the host

- ✚ If some characters are missed or some additional characters are incorrectly displayed on the host, set the Inter-byte delay (0208) to be "01" or greater value.
- ✚ If some capital character (e.g. "A") or compound-key-characters (e.g. "shift+", "Ctrl +", "Alt+") are displayed incorrectly, set the Delay-after-compound-key (0204) to be "01" or greater value.
- ✚ If some digits are incorrectly displayed as some symbol characters (e.g. "1" and "2" are displayed incorrectly as "!" and "@"), set the Clock period (0203) to be greater value (e.g. 04, 05).

Multiple-scan setting			Single-scan setting
Option bar code	Option	Alpha. entry	
Keyboard type  %0201M%	IBM AT, PS/2	00*	 %0201D00% *
	Apple Mac compatibles	01	 %0201D01%
Keyboard layout  %0202M%	USA	00*	 %0202D00% *
	Turkish F	01	 %0202D01%
	Turkish Q	02	 %0202D02%
	French	03	 %0202D03%
	Italian	04	 %0202D04%
	Spanish	05	 %0202D05%
	Slovak	06	 %0202D06%
	Denmark	07	 %0202D07%
	Japanese	08	 %0202D08%
	German	09	 %0202D09%
	Belgian	10	 %0202D10%
Russian	11	 %0202D11%	
Character encoding system  %0413M%	Refer to chapter of "Handheld scan & some global settings"		
Clock period  %0203M%	60us	00	 %0203D00%
	70us	01	 %0203D01%
	80us	02*	 %0203D02% *
	90us	03	 %0203D03%
	100us	04	 %0203D04%
	200us	05	 %0203D05%

Multiple-scan setting			Single-scan setting
Option bar code	Option	Alpha. entry	
Delay-after-compound-key  %0204M%	0ms	00*	 %0204D00% *
	10ms	01	 %0204D01%
	20ms	02	 %0204D02%
	40ms	03	 %0204D03%
	80ms	04	 %0204D04%
Numeric key  %0205M%	Alphabetic key	00*	 %0205D00% *
	Numeric keypad	01	 %0205D01%
	Alt+ keypad	02	 %0205D02%
Power-on simulation  %0206M%	Disable	00*	 %0206D00%
	Enable	01	 %0206D01%
Inter-character delay  %0207M%	0ms	00*	 %0207D00%
	5ms	01	 %0207D01%
	10ms	02	 %0207D02%
	20ms	03	 %0207D03%
	40ms	04	 %0207D04%
	80ms	05	 %0207D05%
Inter-byte delay  %0208M%	1ms	00*	 %0208D00%
	2ms	01	 %0208D01%
	4ms	02	 %0208D02%
	8ms	03	 %0208D03%
Caps Lock reversion  %0209M%	Disable	00*	 %0209D00%
	Enable	01	 %0209D01%

Multiple-scan setting			Single-scan setting
Option bar code	Option	Alpha. entry	
Caps Lock override  %0210M%	Disable	00*	 %0210D00%
	Enable	01	 %0210D01%
 %END%			

## RS-232 interface

### Flow control:

**None**-The communication only uses TxD and RxD signals without any hardware or software handshaking protocol.













**RTS/CTS**- If the scanner wants to send the barcode data to host computer, it will issue the RTS signal first, wait for the CTS signal from the host computer, and then perform the normal data communication. If there is no replied CTS signal from the host computer after the timeout duration, the scanner will issue an error indication. By setting (Host idle: Low RTS) or (Host idle: High RTS), the scanner can be set to match the Serial Host RTS line.



**XON/XOFF**- An XOFF character turns the scanner transmission off until the scanner receives an XON character.

**ACK/NAK**- After transmitting data, the scanner expects either an ACK (acknowledge) or NAK (not acknowledge) response from the host. When a NAK is received, the scanner transmits the same data again and waits for either an ACK or NAK. After three unsuccessful attempts to send data when NAKs are received, the scanner issues an error indication and discards the data.

**Inter-character delay:** Refer to Inter-character delay of Keyboard wedge.

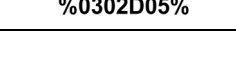
**Response delay:** This delay is used for serial communication of the scanner when it waits for a handshaking acknowledgment from the host.

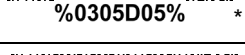
Multiple-scan setting			Single-scan setting
Option bar code	Option	Alpha. entry	
Flow control  %0301M%	None	00*	 %0301D00% *
	RTS/CTS (Host idle: Low RTS)	01	 %0301D01%
	RTS/CTS (Host idle: High RTS)	02	 %0301D02%
	XON/XOFF	03	 %0301D03%
	ACK/NAK	04	 %0301D04%
Inter-character delay  %0302M%	0ms	00*	 %0302D00% *
	5ms	01	 %0302D01%
	10ms	02	 %0302D02%
	20ms	03	 %0302D03%
	40ms	04	 %0302D04%
	80ms	05	 %0302D05%

Multiple-scan setting			Single-scan setting
Option bar code	Option	Alpha. entry	
Response delay  %0304M%	00-99 (100ms)	00-99	
		00*	 %0304D00% *
Baud rate  %0305M%	300	00	 %0305D00%
	600	01	 %0305D01%
	1200	02	 %0305D02%
	2400	03	 %0305D03%
	4800	04	 %0305D04%
	9600	05*	 %0305D05% *
	19200	06	 %0305D06%
	38400	07	 %0305D07%
	57600	08	 %0305D08%
	115200	09	 %0305D09%
Parity bit  %0306M%	None	00*	 %0306D00% *
	Odd	01	 %0306D01%
	Even	02	 %0306D02%
Data bit  %0307M%	8 bits	00*	 %0307D00% *
	7 bits	01	 %0307D01%
Stop bit  %0308M%	One bit	00*	 %0308D00% *
	Two bits	01	 %0308D01%
 %END%			

## USB interface

### USB device type:

**HID keyboard**– By setting, the scanner is used as a USB HID keyboard emulation device. The keyboard layout setting follows the setting of **keyboard layout** in the chapter of Keyboard wedge.

**USB virtual COM**– By setting, the scanner emulate a regular RS232-based COM port. If a Microsoft Windows PC is connected to the scanner, a driver is required to install on the connected PC. The driver will use the next available COM Port number. The driver and the installation guide can be found in the associated CD and on the manufacturer’s website. A Windows-based software COM\_Text is recommended to display the barcode data in text format. COM\_Text emulates some kind of serial-key typing.

Note: when changing USB Device Type, the scanner automatically restarts.

**Simple COM Port Emulation**- Please contact the manufacturer for the instruction.

**Keyboard layout:** The scanner supports different national keyboard layouts.











**Inter-character delay:** This delay is inserted after each data character transmitted. By selecting, the user can change the output speed of the scanner to match the speed of the host USB communication port.

### Numeric key:





















**Alphabetic key**- the scanner will output code result as alphabetic key.

**Numeric key**- the scanner will output code result as pressing numeric keypad ( ‘0’, ‘1’, ‘2’, ‘3’, ‘4’, ‘5’, ‘6’, ‘7’, ‘8’, ‘9’, ‘.’, ‘+’, ‘-’, ‘/’, ‘\*’ only).

**Alt+ keypad**- the scanner will output code result as pressing Alt+ numeric key (on keypad). Note that the Num Lock control key must be ON. This setting can be specially adapted for use with different national keyboard layout.

Multiple-scan setting			Single-scan setting
Option bar code	Option	Alpha. entry	
USB device type  %0901M%	HID keyboard	00*	 %0901D00% *
	HID keyboard for Apple Mac	01	 %0901D01%
	USB virtual COM	02	 %0901D02%
	Simple COM Port Emulation	03	 %0901D03%
Keyboard layout  %0902M%	USA	00*	 %0902D00% *
	Turkish F	01	 %0902D01%
	Turkish Q	02	 %0902D02%
	French	03	 %0902D03%



Multiple-scan setting			Single-scan setting
Option bar code	Option	Alpha. entry	
	Italian	04	 %0902D04%
	Spanish	05	 %0902D05%
	Slovak	06	 %0902D06%
	Denmark	07	 %0902D07%
	Japanese	08	 %0902D08%
	German	09	 %0902D09%
	Belgian	10	 %0902D10%
	Russian	11	 %0902D11%
Character encoding system  %0413M%	Refer to chapter of “Handheld scan & some global settings”		
Inter-character delay  %0903M%	0ms	00	 %0903D00%
	5ms	01*	 %0903D01% *
	10ms	02	 %0903D02%
	20ms	03	 %0903D03%
	40ms	04	 %0903D04%
	60ms	05	 %0903D05%
Numeric key  %0904M%	Alphabetic key	00*	 %0904D00% *
	Numeric keypad	01	 %0904D01%
	Alt+ keypad	02	 %0904D02%
 %END%			

## Hand-held scan & some global settings

### Scanning mode:

**Good-read off**-The trigger button must be pressed once to activate scanning. The light source of scanner stops scanning when there is a successful reading or no code is decoded after the **Stand-by duration** elapsed.

**Momentary**-The trigger button acts as a switch. Press button to activate scanning and release button to stop scanning. The light source of scanner stops scanning when there is a successful reading or no code is decoded after the **Stand-by duration** elapsed.

**Alternate continue**-The trigger button acts as a toggle switch. Press button to activate or stop scanning.

**Continue**-The scanner always keeps scanning, and it does not matter when the trigger button is pressed or duration is elapsed.

**Timeout off**-The trigger button must be pressed once to activate scanning. The light source of scanner stops scanning when no code is successful decoded after the **Stand-by duration** elapsed.

**Same barcode delay time:** If a barcode has been scanned and output once successfully, the laser beam must be off or moved away from the barcode beyond delay time to active scanning the same barcode. When this feature is set to be "0xFF", then the delay time is indefinite.

**Double confirm:** If it is enabled, the scanner will require a several times of same-decoded-data to confirm a valid reading.

**Global Max./Min. code length for 1D symbol:** These two lengths are defined as the valid range of decoded 1D barcode data length. Make sure that the minimum length setting is no greater than the maximum length setting, or otherwise the labels of the symbol will not be readable. In particular, the same value can be set for both minimum and maximum reading length to force the fixed length barcode decoded.

### Notes:

1. Please set the max./min. length for individual barcode in later sections, if special demand is requested.
2. The number of check digits is included in max./min. code length.
3. These two settings have no effect on the symbols with fixed-length, e.g. UPC-A, UPC-E, EAN-13, EAN-8 and China Post.

**Global G1-G6 string selection:** The scanner offer one or two string group for ALL symbols. By setting one or two digits to indicate which string group you want to apply. You may refer to the chapters of "String setting" and "String position & Number of truncated leading/ending character".

Example: Group 1 → set 01 or 10. Group 2 and 4 → set 24 or 42.

All valid settings include 00, 01, 02, 03, 04, 05, 06, 10, 11, 12, 13, 14, 15, 16, 20, 21, 22, 23, 24, 25, 26, 30, 31, 32, 33, 34, 35, 36, 40, 41, 42, 43, 44, 45, 46, 50, 51, 52, 53, 54, 55, 56, 60, 61, 62, 63, 64, 65 and 66.

**Element amendment:** If it is enabled, the scanner can read the barcode comprised with bars and spaces in different scale.

**Character output restraint:**

**Printable character only-** If this option is selected, the scanner will output the printable characters only, i.e. in ASCII from 20H to 7EH.





















**Alphanumeric character only-** If this option is selected, the scanner will output the alphanumeric characters only, i.e. “A”-“Z”, “a”-“z”, “0”-“9”.

**Decoder optimization:** If it is enabled, the scanner will optimize the decoder with error correction. This function is not effective for all types of barcodes.

**Data output delay in continue-scan mode:** If it is enabled, in the continue-scan mode, the scanner can store the data while continue-scanning. The scanner will output the data after the predefined delay elapsed. The maximum storage of data is 1000 characters. If this parameter is set to be “00”, the scanner will not store data. And if the parameter is set to be “FF”, the scanner will output data after stopping scanning.

**Character encoding system:** A character encoding system consists of a code that pairs each character from a given repertoire. Common examples include Morse code, the Baudot code, the ASCII and Unicode. If the data received does not display with the proper characters, it may be because the barcode being scanned was created using a character encoding system that is different from the one the host program is expecting. Try alternate options to find the proper one.

Multiple-scan setting			Single-scan setting
Option bar code	Option	Alpha. entry	
Scanning mode  %0401M%	Good-read off	00	 %0401D00%
	Momentary	01*	 %0401D01% *
	Alternate continue	02	 %0401D02%
	Continue	03	 %0401D03%
	Timeout off	04	 %0401D04%
Standby duration  %0402M%	01-99 (second)	01-99	
		04*	 %0402D04%
Same barcode delay time  %0403M%	00-FF <sub>16</sub> (50ms)	00-FF <sub>16</sub>	
		08*	 %0403H08%
Double confirm  %0404M%	00-09 (00: no )	00-09	
		00*	 %0404D00% *
Global max. code length for 1D symbol	04-99	04-99	

Multiple-scan setting			Single-scan setting
Option bar code	Option	Alpha. entry	
 %0405M%		99*	 %0405D99% *
Global min. code length for 1D symbol  %0406M%	01-99	01-99	
		04*	 %0406D04% *
Global G1-G6 string selection  %0407M%	00-66	00-66	
		00*	 %0407D00%
Element amendment  %0408M%	Disable	00	 %0408D00%
	Enable	01*	 %0408D01% *
Character output restraint  %0409M%	None	00*	 %0409D00%
	Printable character only	01	 %0409D01%
	Alphanumeric character only	02	 %0409D02%
Decoder optimization  %0410M%	Disable	00	 %0410D00%
	Enable	01*	 %0410D01%
Data output delay in continue-scan mode  %0411M%	00-99 (100ms)	00-FF <sub>16</sub>	
	FF (Never)	00*	 %0411H00% *
Character encoding system  %0413M%	ASCII	00*	 %0413D00% *
	UTF-8	01	 %0413D01%
	Windows-1251	02	 %0413D02%
 %END%			

## Indication









**Power on alert:** After power-on the scanner will generate an alert signal to indicate a successful self-test.

**LED indication:** After each successful reading, the LED above the scanner will light up to indicate a good barcode reading.

**Beeper indication:** After each successful reading, the scanner will beep to indicate a good barcode reading, and its beep tone duration is adjustable.

**Beep tone duration:** This parameter can be adjusted for a good reading upon favorite usage.

**Volume of beeper:** This parameter can be adjusted for different level of the volume of the beeper.

Multiple-scan setting			Single-scan setting
Option bar code	Option	Alpha. entry	
Power on alert  %0501M%	Disable	00	 %0501D00%
	Enable	01*	 %0501D01% *
LED indication  %0502M%	Disable	00	 %0502D00%
	Enable	01*	 %0502D01% *
Beeper indication  %0503M%	Disable	00	 %0503D00%
	Enable	01*	 %0503D01%
Beep tone duration  %0504M%	01-09 (10ms )	01-09	
		05*	 %0504D05% *
Volume of beeper  %0505M%	Low	00	 %0505D00%
	Middle	01	 %0505D01%
	High	02*	 %0505D02% *



## Decode illumination and decode aiming pattern

**Decode illumination mode:** Enable illumination causes the scanner to turn on the illumination to aid decoding. Disable illumination to turn off illumination for the scanner during decoding. Better quality images could be obtained with illumination support. The effectiveness of the illumination decreases as the distance to the target increases.

**Decode aiming pattern:** When this option is enabled, the scanner will project the aiming pattern during the code capture.

Multiple-scan setting			Single-scan setting
Option bar code	Option	Alpha. Entry	
Decode illumination  %9001M%	Always Off	00	 %9001D00%
	Always On	01	 %9001D01%
	Flashing	02*	 %9001D02% *
	On when reading	03	 %9001D03%
Decode aiming pattern  %9002M%	Always Off	00	 %9002D00%
	Always On	01	 %9002D01%
	On before reading	02	 %9002D02%
	On when reading	03*	 %9002D03% *
 %END%			

## DPM, Multiple symbols, Structured append, etc. read setting

**2D symbols read:** A global setting of 2D symbols readability.

**DPM format read:** By setting Enable, the scanner can read 2D symbols in DPM (Direct Park Marking) format. Some barcodes in DPM format are shown below.

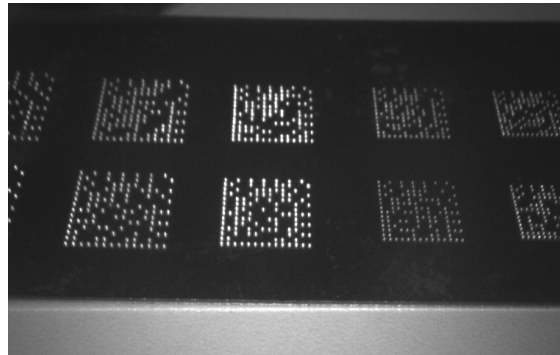
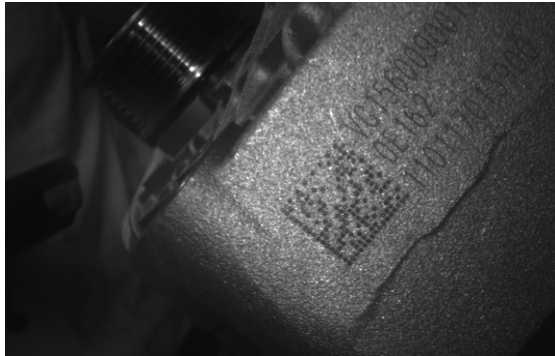

### Multiple symbols & structured append symbols read:

1) By setting Enable, the scanner allows to read multiple symbols with a single pull of the scanner's trigger. If the user pulls and holds the trigger, aiming the scanner at a series of symbols, it reads unique symbols once, beeping for each success read. The scanner attempts to find and decode new symbols as long as the trigger is pulled.

2) By setting Enable, the scanner will output data only when all Structured Append symbols have been decoded. The lower part of below figure shows an example of four Structured Append symbols, with the same data as that in the upper symbol.

3) By setting Disable, the scanner will only read the symbol closest to the aiming beam.

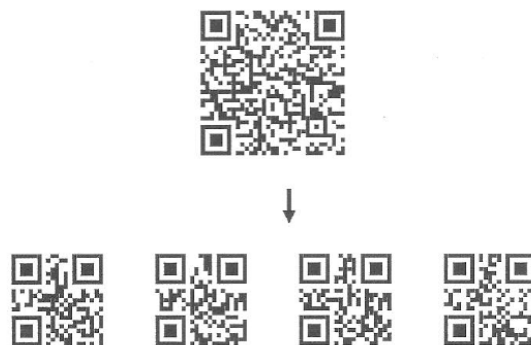



















Single symbol (above) and Structured Append series of symbols (below) encoding  
"ABCDEFGHIJKLMNOPQRSTUVWXYZ0123456789ABCDEFGHIJKLMNOPQRSTUVWXYZ"

**Vertical centering read:** By setting Enable, the scanner reads only the barcode centered by the aimer in vertical direction. However, the scanner will read either one of two barcodes which are positioned horizontally. See example below.





Multiple-scan setting			Single-scan setting
Option bar code	Option	Alpha. entry	
2D symbols read  %1001M%	Follow respective 2D symbol setting	00*	 %1001D00% *
	All 2D OFF	01	 %1001D01%
	All 2D ON	02	 %1001D02%
	Only PDF417 ON	03	 %1001D03%
	Only QR code ON	04	 %1001D04%
	Only Data Matrix ON	05	 %1001D05%
	Only MaxiCode ON	06	 %1001D06%
	Only Aztec Code ON	07	 %1001D07%
	Only Han Xin Code ON	08	 %1001D08%
DPM format read  %1002M%	Disable	00*	 %1002D00% *
	Enable	01	 %1002D01%
Decode multi-symbols in one read  %1003M%	Multi-symbols	00	 %1003D00%
	One symbol only	01*	 %1003D01% *
Vertical centering read  %1004M%	Disable	00*	 %1004D00% *
	Enable	01	 %1004D01%



Note: The instruction of calibrating the aimer in vertical centering direction.

1. Scan the barcode on this page. The scanner will give three musical short beeps to indicate entering calibration mode.
2. Press the trigger of the scanner while maintaining the distance of about 15cm between the exit window of the scanner and this paper. After a few seconds, the scanner will give three short beeps to indicate a successful calibration, or a long beep to indicate a failed calibration.
3. If the calibration is failed in step 2, please repeat the steps 1-2. If it is not succeed after a multiple times of calibration, please contact your local dealer or the manufacturer for further instruction.



# UPC-A

**Read:**

Format

System character	Data digits (10 digits)	Check digit
------------------	-------------------------	-------------

**Check digit verification:** The check digit is optional.

**Check digit trans.:** By setting Enable, check digit will be transmitted.

**Code ID setting:** Code ID is a one-or-two-character string used to represent the symbol upon a succeeding reading. If you want application to transmit Code ID, you must set **Code ID transmission** to be enabled. Refer to the chapter of String transmission.

**Insertion group selection:** Refer to **Global insertion group selection** of the chapter of Hand-held scan & some global settings.

**Supplement digits:** The Supplement digits barcode is the supplemental 2 or 5 characters.

Format

System character	Data digits (10 digits)	Check digit	Supplement digits 2 or 5
------------------	-------------------------	-------------	--------------------------











**Truncation/Expansion:**













**Truncate leading zeros-** The leading “0” digits of UPC-A data characters can be truncated when the feature is enabled.

**Expand to EAN-13-** It extends to 13-digits with a “0” leading digit when the feature is enabled.

**Truncate system character-** The system character of UPC-A data can be truncated when the feature is enabled.

**Add country code-** The country code (“0” for USA) can be added when the feature is enabled.

Multiple-scan setting			Single-scan setting
Option bar code	Option	Alpha. entry	
Read  %1101M%	Disable	00	 %1101D00%
	Enable	01*	 %1101D01% *
Check digit verification  %1102M%	Disable	00	 %1102D00%
	Enable	01*	 %1102D01% *
Check digit trans.  %1103M%	Disable	00	 %1103D00%
	Enable	01*	 %1103D01% *
Code ID setting  %1104M%	00-FF <sub>16</sub> (ASCII)	00-FF <sub>16</sub>	
		<A>*	 %1104H41% *

Multiple-scan setting			Single-scan setting
Option bar code	Option	Alpha. entry	
Insert group selection  %1105M%	00-66	00-66	
		00*	 %1105D00%
Supplement digits  %1106M%	None	00*	 %1106D00% *
	2 digits	01	 %1106D01%
	5 digits	02	 %1106D02%
	2 or 5 digits	03	 %1106D03%
Truncation/Expansion  %1107M%	None	00*	 %1107D00% *
	Truncate leading zeros	01	 %1107D01%
	Expand to EAN-13	02	 %1107D02%
	Truncate system character	03	 %1107D03%
	Add country code	04	 %1107D04%



# UPC-E

**Read:**

Format

System character "0"	Data digits (6 digits)	Check digits
----------------------	------------------------	--------------

**Check digit verification:** The check digit is optional and made as the sum of the numerical value of the data digits.

**Check digit trans.:** By setting Enable, check digit will be transmitted.

**Code ID setting:** Refer to 

Code ID setting
-----------------

 of UPC-A.

**Insertion group selection:** Refer to 

Insertion group selection
---------------------------

 of UPC-A.

**Supplement digits:**

Format

System character "0"	Data digits (6 digits)	Check digit	Supplement digits 2 or 5
----------------------	------------------------	-------------	--------------------------

**Truncation/Expansion:**

**Truncate leading zeros-** Refer to 

Truncation/Expansion
----------------------

 of UPC-A.











**Expand to EAN-13-** It extends to 13-digits with "0" digits when the feature is set to be enabled.













Example: Barcode "0123654",

Output: "0012360000057".

**Expand to UPC-A-** It extends to 12-digits when the feature is set to be enabled.

**Truncate system character-** The system character "0" of UPC-E data can be truncated when the feature is enabled.

Multiple-scan setting			Single-scan setting
Option bar code	Option	Alpha. entry	
Read  %1201M%	Disable	00	 %1201D00%
	Enable	01*	 %1201D01% *
Check digit verification  %1202M%	Disable	00	 %1202D00%
	Enable	01*	 %1202D01% *
Check digit trans.  %1203M%	Disable	00	 %1203D00%
	Enable	01*	 %1203D01% *
Code ID setting  %1204M%	00-FF <sub>16</sub> (ASCII)	00-FF <sub>16</sub>	
		<D>*	 %1204H20% *
Insert group selection	00-66	00-66	

Multiple-scan setting			Single-scan setting
Option bar code	Option	Alpha. entry	
 %1205M%		00*	 %1205D00% *
Supplement digits  %1206M%	None	00*	 %1206D00% *
	2 digits	01	 %1206D01%
	5 digits	02	 %1206D02%
	2 or 5 digits	03	 %1206D03%
Truncation/Expansion  %1207M%	None	00*	 %1207D00% *
	Truncate leading zeros	01	 %1207D01%
	Expand to EAN-13	02	 %1207D02%
	Expand to UPC-A	03	 %1207D03%
	Truncate system character	04	 %1207D04%



# UPC-E1

Read:

Format

Leading zero	"1"	Following 5 data digits	Check digits
--------------	-----	-------------------------	--------------

**Check digit verification:** The check digit is optional and made as the sum of the numerical value of the data digits.

**Check digit trans.:** By setting Enable, check digit will be transmitted.

**Code ID setting:** Refer to 

Code ID setting
-----------------

 of UPC-A.

**Insertion group selection:** Refer to 

Insertion group selection
---------------------------

 of UPC-A.

**Supplement digits:**

Format

Leading zero	Data digits (6 digits)	Check digit	Supplement digits 2 or 5
--------------	------------------------	-------------	--------------------------

**Truncation/Expansion:**

**Truncate leading zeros-** Refer to 





Truncation/Expansion
----------------------













 of UPC-A.

**Expand to EAN-13-** It extends to 13-digits with "0" digits when the feature is set to be enabled.

**Expand to UPC-A-** It extends to 12-digits when the feature is set to be enabled.

**Truncate system character-** The system character "1" of UPC-E1 data can be truncated when the feature is enabled.

Multiple-scan setting			Single-scan setting
Option bar code	Option	Alpha. entry	
Read  %3401M%	Disable	00	 %3401D00%
	Enable	01*	 %3401D01% *
Check digit verification  %3402M%	Disable	00	 %3402D00%
	Enable	01*	 %3402D01% *
Check digit trans.  %3403M%	Disable	00	 %3403D00%
	Enable	01*	 %3403D01% *
Code ID setting  %3404M%	00-FF <sub>16</sub> (ASCII)	00-FF <sub>16</sub>	
		<D>*	 %3404H20% *
Insert group selection  %3405M%	00-66	00-66	
		00*	 %3405D00% *

Multiple-scan setting			Single-scan setting
Option bar code	Option	Alpha. entry	
Supplement digits  %3406M%	None	00*	 %3406D00% *
	2 digits	01	 %3406D01%
	5 digits	02	 %3406D02%
	2 or 5 digits	03	 %3406D03%
Truncation/Expansion  %3407M%	None	00*	 %3407D00% *
	Truncate leading zeros	01	 %3407D01%
	Expand to EAN-13	02	 %3407D02%
	Expand to UPC-A	03	 %3407D03%
	Truncate system character	04	 %3407D04%
 %END%			



## EAN-13 (ISBN/ISSN)

### Read:

Format

Data digits (12 digits)	Check digit
-------------------------	-------------

**Check digit verification:** The check digit is optional and made as the sum of the numerical value of the data digits.

**Check digit transmission:** By setting Enable, check digit will be transmitted.

**EAN-13 code ID setting:** Refer to 

Code ID setting
-----------------

 of UPC-A.

**Insertion group selection:** Refer to 

Insertion group selection
---------------------------

 of UPC-A.

### Supplement digits:

Format

Data digits (12 digits)	Check digit	Supplement digits 2 or 5
-------------------------	-------------	--------------------------

**ISBN/ISSN:** The ISBN (International Standard Book Number, or Bookland EAN) and ISSN (International Standard Serial Number) are two kinds of barcode for books and magazines. The ISBN is 10 digits with leading "978" and the ISSN is 8 digits with leading "977" of the EAN-13 symbol.

Example:

Barcode "9780194315104", Output: "019431510X".

Barcode "9771005180004", Output: "10051805".

**ISBN/ISSN code ID setting:** Refer to 

Code ID setting
-----------------

 of UPC-A.

Multiple-scan setting			Single-scan setting
Option bar code	Option	Alpha. entry	
Read  %1301M%	Disable	00	 %1301D00%
	Enable	01*	 %1301D01% *
Check digit verification  %1302M%	Disable	00	 %1302D00%
	Enable	01*	 %1302D01% *
Check digit transmission  %1303M%	Disable	00	 %1303D00%
	Enable	01*	 %1303D01% *
EAN-13 code ID setting  %1304M%	00-FF <sub>16</sub>	00-FF <sub>16</sub>	
	(ASCII)	<A>*	 %1304H41% *
Insert group selection  %1305M%	00-66	00-66	
		00*	 %1305D00% *
Supplement digits  %1306M%	None	00*	 %1306D00% *
	2 digits	01	 %1306D01%
	5 digits	02	 %1306D02%
	2 or 5 digits	03	 %1306D03%
ISBN/ISSN conversion  %1307M%	Disable	00*	 %1307D00% *
	Enable	01	 %1307D01%
ISBN/ISSN code ID setting  %1309M%	00-FF <sub>16</sub>	00-FF <sub>16</sub>	
	(ASCII)	<B>*	 %1309H42% *



## EAN-8

### Read:

Format

Data digits (7 digits)	Check digit
------------------------	-------------

**Check digit verification:** The check digit is optional and made as the sum of the numerical value of the data digits.

**Check digit trans.:** By setting Enable, check digit will be transmitted.

**Code ID setting:** Refer to 

Code ID setting
-----------------

 of UPC-A.

**Insertion group selection:** Refer to 

Insertion group selection
---------------------------

 of UPC-A.

### Supplement digits:

Format

Data digits (7 digits)	Check digit	Supplement Digits 2 or 5
------------------------	-------------	--------------------------

**Truncation/Expansion:** Refer to 

Truncation/Expansion
----------------------

 of UPC-A.

Multiple-scan setting			Single-scan setting
Option bar code	Option	Alpha. entry	
Read  %1401M%	Disable	00	 %1401D00%
	Enable	01*	 %1401D01% *
Check digit verification  %1402M%	Disable	00	 %1402D00%
	Enable	01*	 %1402D01% *
Check digit trans.  %1403M%	Disable	00	 %1403D00%
	Enable	01*	 %1403D01% *
Code ID setting  %1404M%	00-FF <sub>16</sub> (ASCII)	00-FF <sub>16</sub>	
		<C>*	 %1404H42% *
Insert group selection  %1405M%	00-66	00-66	
		00*	 %1405D00% *
Supplement digits  %1406M%	None	00*	 %1406D00% *
	2 digits	01	 %1406D01%
	5 digits	02	 %1406D02%
	2 or 5 digits	03	 %1406D03%
Truncation/Expansion  %1407M%	None	00*	 %1407D00% *
	Truncate leading zero	01	 %1407D01%
	Expand to EAN-13	02	 %1407D02%



## Code 39 (Code 32, Trioptic Code 39)

### Read:

#### Format

★	Data digits (variable)	Check digit (optional)	★
---	------------------------	------------------------	---

**Check digit verification:** The check digit is optional and made as the sum module 43 of the numerical value of the data digits.

**Check digit transmission:** By setting Enable, check digit will be transmitted.

**Max./Min. code length:** Each symbol has own max./min. code length. If both setting of max./min. code length are "00"s, the setting of global max./min. code length is effective. The length is defined as to the actual barcode data length to be sent. Label with length exceeds these limits will be rejected. Make sure that the minimum length setting is no greater than the maximum length setting, or otherwise all the labels of the symbol will not be readable. In particular, you can see the same value for both minimum and maximum reading length to force the fixed length barcode decoded.

**Code ID setting:** Refer to 

Code ID setting
-----------------

 of UPC-A.

**Insertion group selection:** Refer to 

Insertion group selection
---------------------------

 of UPC-A.

**Start/End transmission:** The start and end characters of Code 39 are "★"s. You can transmit all data digits including two "★"s.

**"★" as data character:** By setting Enable, "★" can be recognized as data character.

**Convert Code 39 to Code 32:** Code 32 is a variant of Code 39 used by the Italian pharmaceutical industry. Note that Code 39 must be enabled in order for this parameter to function.

#### Format of Code 32

"A" (optional)	Data digits (8 digits)	Check digit
----------------	------------------------	-------------





**Code 32 Prefix "A" transmission:** By setting Enable, the prefix character "A" can be added to all Code 32 barcodes.

**Trioptic Code 39 read:** Trioptic Code 39 is a variant of Code 39 used in the marking of magnetic tapes and computer cartridges. Trioptic Code 39 symbols always contain six characters.

#### Format

\$	Data digits (6 digits)	\$
----	------------------------	----

**Trioptic Code 39 Start/End transmission:** The start and end characters of Trioptic Code 39 are "\$"s. You can transmit all data digits including two "\$"s.

Multiple-scan setting			Single-scan setting
Option bar code	Option	Alpha. entry	
Read  %1501M%	Disable	00	 %1501D00%
	Enable	01*	 %1501D01% *
Check digit verification  %1502M%	Disable	00*	 %1502D00% *
	Enable	01	 %1502D01%
Check digit transmission  %1503M%	Disable	00*	 %1503D00% *
	Enable	01	 %1503D01%
Max. code length  %1504M%	00-99	00-99	
		00*	 %1504D00% *
Min. code length  %1505M%	00-99	00-99	
		01*	 %1505D01% *
Code ID setting  %1506M%	00-FF <sub>16</sub> (ASCII)	00-FF <sub>16</sub>	
		<M>*	 %1506H4D% *
Insert group selection  %1507M%	00-66	00-66	
		00*	 %1507D00% *
Format  %1508M%	Standard	00*	 %1508D00% *
	Full ASCII	01	 %1508D01%
Start/End transmission  %1509M%	Disable	00*	 %1509D00% *
	Enable	01	 %1509D01%
“*” as data character  %1510M%	Disable	00*	 %1510D00% *
	Enable	01	 %1510D01%
Convert Code 39 to Code 32	Disable	00*	 %1511D00% *

Multiple-scan setting			Single-scan setting
Option bar code	Option	Alpha. entry	
 %1511M%	Enable	01	 %1511D01%
Code 32 Prefix "A" transmission  %1512M%	Disable	00*	 %1512D00% *
	Enable	01	 %1512D01%
Trioptic Code 39 read  %1513M%	Disable	00*	 %1513D00% *
	Enable	01	 %1513D01%
Trioptic Code 39 Start/End transmission  %1514M%	Disable	00*	 %1514D00% *
	Enable	01	 %1514D01%

  
%END%

## Interleaved 2 of 5

**Read:**

Format

Data digits (Variable)	Check digit (optional)
------------------------	------------------------

**Check digit verification:** The check digit is made as the sum module 10 of the numerical values of all data digits. There are two optional check digit algorithms: the specified Uniform Symbol Specification (USS) and the Optical Product Code Council (OPCC).

**Check digit transmission:** By setting Enable, check digit will be transmitted.

**Max./Min. code length:** Refer to 

Max./Min. code length
-----------------------

 of Code 39.

**Code ID setting:** Refer to 

Code ID setting
-----------------

 of UPC-A.

**Insertion group selection:** Refer to 

Insertion group selection
---------------------------

 of UPC-A.



Multiple-scan setting			Single-scan setting
Option bar code	Option	Alpha. entry	
Read  %1601M%	Disable	00	 %1601D00%
	Enable	01*	 %1601D01% *
Check digit verification  %1602M%	Disable	00*	 %1602D00% *
	USS	01	 %1602D01%
	OPCC	02	 %1602D02%
Check digit transmission  %1603M%	Disable	00*	 %1603D00% *
	Enable	01	 %1603D01%
Max. code length  %1604M%	00-99	00-99	
		00*	 %1604D00% *
Min. code length  %1605M%	00-99	00-99	
		06*	 %1605D06% *
Code ID setting  %1606M%	00-FF <sub>16</sub> (ASCII)	00-FF <sub>16</sub>	
		< >*	 %1606H49% *
Insert group selection  %1607M%	00-66	00-66	
		00*	 %1607D00% *



## Industrial 2 of 5

Read:

Format

Data digits (variable)

Max./Min. code length: Refer to Max./Min. code length of Code 39.

Code ID setting: Refer to Code ID setting of UPC-A.

Insertion group selection: Refer to Insertion group selection of UPC-A.

Multiple-scan setting			Single-scan setting
Option bar code	Option	Alpha. entry	
Read  %1701M%	Disable	00*	 %1701D00% *
	Enable	01	 %1701D01%
Max. code length  %1702M%	00-99	00-99	
		00*	 %1702D00% *
Min. code length  %1703M%	00-99	00-99	
		00*	 %1703D00% *
Code ID setting  %1704M%	00-FF <sub>16</sub> (ASCII)	00-FF <sub>16</sub>	
		<H>*	 %1704H48% *
Insert group selection  %1705M%	00-66	00-66	
		00*	 %1705D00% *
 %END%			

## Matrix 2 of 5

Read:

Format

Data digits (variable)	Check digit (optional)
------------------------	------------------------

**Check digit verification:** The check digit is made as the sum module 10 of the numerical values of all data digits.

**Check digit transmission:** By setting Enable, check digit will be transmitted.

**Max./Min. code length:** Refer to Max./Min. code length of Code 39.

**Code ID setting:** Refer to Code ID setting of UPC-A.

**Insertion group selection:** Refer to Insertion group selection of UPC-A.

Multiple-scan setting			Single-scan setting
Option bar code	Option	Alpha. entry	
Read  %1801M%	Disable	00	 %1801D00%
	Enable	01*	
Check digit verification  %1802M%	Disable	00*	 %1802D00% *
	Enable	01	 %1802D01%
Check digit transmission  %1803M%	Disable	00*	 %1803D00% *
	Enable	01	 %1803D01%
Max. code length  %1804M%	00-99	00-99	 %1804D00% *
		00*	
Min. code length  %1805M%	00-99	00-99	 %1805D06% *
		06*	
Code ID setting  %1806M%	00-FF <sub>16</sub> (ASCII)	00-FF <sub>16</sub>	 %1806H58% *
		<X>*	
Insert group selection  %1807M%	00-66	00-66	 %1807D00% *
		00*	

  
 %END%

# Codabar

Read:

Format

Start	Data digits (variable)	Check digit (optional)	End
-------	------------------------	------------------------	-----

**Check digit verification:** The check digit is made as the sum module 16 of the numerical values of all data digits.

**Check digit transmission:** By setting Enable, check digit will be transmitted.

**Max./Min. code length:** Refer to **Max./Min. code length** of Code 39.















**Code ID setting:** Refer to **Code ID setting** of UPC-A.















**Insertion group selection:** Refer to **Insertion group selection** of UPC-A.

**Start/End type:** Codabar has four pairs of Start/End pattern; you may select one pair to match your application.

**Start/End transmission:** Refer to **Start/End transmission** of Code 39.

**Start/End character equality:** By setting Enable, the start and end character of a Codabar barcode must be the same.

Multiple-scan setting			Single-scan setting
Option bar code	Option	Alpha. entry	
Read  %1901M%	Disable	00	 %1901D00%
	Enable	01*	 %1901D01% *
Check digit verification  %1902M%	Disable	00*	 %1902D00% *
	Enable	01	 %1902D01%
Check digit transmission  %1903M%	Disable	00*	 %1903D00% *
	Enable	01	 %1903D01%
Max. code length  %1904M%	00-99	00-99	
		00*	 %1904D00% *
Min. code length  %1905M%	00-99	00-99	
		00*	 %1905D00% *
Code ID setting  %1906M%	00-FF <sub>16</sub> (ASCII)	00-FF <sub>16</sub>	
		<N>*	 %1906H4E% *

Multiple-scan setting			Single-scan setting
Option bar code	Option	Alpha. entry	
Insert group selection  %1907M%	00-66	00-66	
		00*	 %1907D00% *
Start/End type  %1908M%	ABCD/ABCD	00*	 %1908D00% *
	abcd/abcd	01	 %1908D01%
	ABCD/TN*E	02	 %1908D02%
	abcd/tn*e	03	 %1908D03%
Start/End transmission  %1909M%	Disable	00*	 %1909D00% *
	Enable	01	 %1909D01%
Start/End character equality  %1910M%	Disable	00*	 %1910D00% *
	Enable	01	 %1910D01%
 %END%			

## Code 128

Read:

Format

Data digits (variable)	Check digit (optional)
------------------------	------------------------

**Check digit verification:** The check digit is made as the sum module 103 of all data digits.

**Check digit transmission:** By setting Enable, check digit will be transmitted.

**Max./Min. code length:** Refer to 

Max./Min. code length
-----------------------

 of Code 39.

**Code ID setting:** Refer to 

Code ID setting
-----------------

 of UPC-A.

**Insertion group selection:** Refer to 

Insertion group selection
---------------------------

 of UPC-A.

**Truncate leading zeros:** The leading "0" digits of Code 128 barcode characters can be truncated when the feature is enabled.

Multiple-scan setting			Single-scan setting
Option bar code	Option	Alpha. entry	
Read  %2001M%	Disable	00	 %2001D00%
	Enable	01*	 %2001D01% *
Check digit verification  %2002M%	Disable	00	 %2002D00%
	Enable	01*	 %2002D01% *
Check digit transmission  %2003M%	Disable	00*	 %2003D00% *
	Reserved	01	 %2003D01%
Max. code length  %2004M%	00-99	00-99	
		00*	 %2004D00% *
Min. code length  %2005M%	00-99	00-99	
		01*	 %2005D01% *
Code ID setting  %2006M%	00-FF <sub>16</sub> (ASCII)	00-FF <sub>16</sub>	
		<K>*	 %2006H4B% *
Insert group selection  %2007M%	00-66	00-66	
		00*	 %2007D00% *
Truncate leading zeros  %2008M%	Disable	00*	 %2008D00% *
	All leading "0"s	01	 %2008D01%
	Only the first "0"	02	 %2008D02%

  
 %END%

## UCC/EAN 128

**Read:**

Format

Data digits (variable)	Check digit (optional)
------------------------	------------------------

**Check digit verification:** The check digit is made as the sum module 103 of all data digits.

**Check digit transmission:** By setting Enable, check digit will be transmitted.

**Max. /Min. code length:** Refer to 

Max./Min. code length
-----------------------

 of Code 39.

**Code ID setting:** Refer to 

Code ID setting
-----------------

 of UPC-A.

**Insertion group selection:** Refer to 

Insertion group selection
---------------------------

 of UPC-A.

**Truncate leading zeros:** Refer to 

Truncate leading zeros
------------------------

 of Code 128.



Multiple-scan setting			Single-scan setting
Option bar code	Option	Alpha. entry	
Read  %2501M%	Disable	00	 %2501D00%
	Enable	01*	 %2501D01% *
Check digit verification  %2502M%	Disable	00	 %2502D00%
	Enable	01*	 %2502D01% *
Check digit transmission  %2503M%	Disable	00*	 %2503D00% *
	Reserved	01	 %2503D01%
Max. code length  %2504M%	00-99	00-99	
		00*	 %2504D00% *
Min. code length  %2505M%	00-99	00-99	
		01*	 %2505D01% *
Code ID setting  %2506M%	00-FF <sub>16</sub> (ASCII)	00-FF <sub>16</sub>	
		<K>*	 %2506H4B% *
Insert group selection  %2507M%	00-66	00-66	
		00*	 %2507D00% *
Truncate leading zeros  %2508M%	Disable	00*	 %2508D00% *
	All leading "0"s	01	 %2508D01%
	Only the first "0"	02	 %2508D02%



# ISBT 128

Read:

Format

“=” or “&”	Data digits (variable)	Check digit (optional)
------------	------------------------	------------------------















**Check digit verification:** The check digit is made as the sum module 103 of all data digits.

**Check digit transmission:** By setting Enable, check digit will be transmitted.

**Max./Min. code length:** Refer to Max./Min. code length of Code 39.

**Code ID setting:** Refer to Code ID setting of UPC-A.

**Insertion group selection:** Refer to Insertion group selection of UPC-A.

Multiple-scan setting			Single-scan setting
Option bar code	Option	Alpha. entry	
Read  %3301M%	Disable	00	 %3301D00%
	Enable	01*	 %3301D01% *
Check digit verification  %3302M%	Disable	00	 %3302D00%
	Enable	01*	 %3302D01% *
Check digit transmission  %3303M%	Disable	00*	 %3303D00% *
	Reserved	01	 %3303D01%
Max. code length  %3304M%	00-99	00-99	
		00*	 %3304D00% *
Min. code length  %3305M%	00-99	00-99	
		01*	 %3305D01% *
Code ID setting  %3306M%	00-FF <sub>16</sub> (ASCII)	00-FF <sub>16</sub>	
		<K>*	 %3306H4B% *
Insert group selection  %3307M%	00-66	00-66	
		00*	 %3307D00% *
 %END%			

# Code 93

Read:

Format

Data digits (variable)	2 check digits (optional)
------------------------	---------------------------













**Check digit verification:** The check digit is made as the sum module 47 of the numerical values of all data digits.

**Check digit transmission:** By setting Enable, check digit will be transmitted.

**Max./Min. code length:** Refer to Max./Min. code length of Code 39.

**Code ID setting:** Refer to Code ID setting of UPC-A.

**Insertion group selection:** Refer to Insertion group selection of UPC-A.

Multiple-scan setting			Single-scan setting
Option bar code	Option	Alpha. entry	
Read  %2101M%	Disable	00	 %2101D00%
	Enable	01*	
Check digit verification  %2102M%	Disable	00	 %2102D00%
	Enable	01*	
Check digit transmission  %2103M%	Disable	00*	 %2103D00% *
	Enable	01	
Max. code length  %2104M%	00-99	00-99	 %2104D00% *
		00*	
Min. code length  %2105M%	00-99	00-99	 %2105D01% *
		01*	
Code ID setting  %2106M%	00-FF <sub>16</sub> (ASCII)	00-FF <sub>16</sub>	 %2106H4C% *
		<L>*	
Insert group selection  %2107M%	00-66	00-66	 %2107D00% *
		00*	
 %END%			

## Code 11

**Read:**

Format

Data digits (variable)	Check digit 1 (optional )	Check digit 2 (optional)
------------------------	---------------------------	--------------------------

**Check digit verification:** The check digit is presented as the sum module 11 of all data digits.

**Check digit transmission:** By setting Enable, check digit 1 and check digit 2 will be transmitted upon your selected check digit verification method.

**Max./Min. code length:** Refer to 

Max./Min. code length
-----------------------

 of Code 39.

**Code ID setting:** Refer to 



















Code ID setting
-----------------

 of UPC-A.

**Insertion group selection:** Refer to 

Insertion group selection
---------------------------

 of UPC-A.

Multiple-scan setting			Single-scan setting
Option bar code	Option	Alpha. entry	
Read  %2201M%	Disable	00*	 %2201D00% *
	Enable	01	 %2201D01%
Check digit verification  %2202M%	Disable	00	 %2202D00%
	One digit	01*	 %2202D01% *
	Reserved	02	 %2202D02%
	Reserved	03	 %2202D03%
Check digit transmission  %2203M%	Disable	00*	 %2203D00% *
	Enable	01	 %2203D01%
Max. code length  %2204M%	00-99	00-99	
		00*	 %2204D00% *
Min. code length  %2205M%	00-99	00-99	
		00*	 %2205D00% *
Code ID setting  %2206M%	00-FF <sub>16</sub> (ASCII)	00-FF <sub>16</sub>	
		<V>*	 %2206H56% *
Insert group selection  %2207M%	00-66	00-66	
		00*	 %2207D00% *

  
 %END%

## MSI/Plessey

**Read:**

Format

Data digits (variable)	Check digit 1 (optional)	Check digit 2 (optional)
------------------------	--------------------------	--------------------------

**Check digit verification:** The MSI/Plessey has one or two optional check digits. There are three methods of verifying check digits, i.e. Mod10, Mod10/10 and Mod 11/10. The check digit 1 and check digit 2 will be calculated as the sum module 10 or 11 of the data digits.

**Check digit transmission:** By setting Enable, check digit 1 and check digit 2 will be transmitted upon your selected check digit verification method.

**Max./Min. code length:** Refer to 

Max./Min. code length
-----------------------

 of Code 39.

**Code ID setting:** Refer to 











Code ID setting
-----------------

 of UPC-A.

**Insertion group selection:** Refer to 

Insertion group selection
---------------------------

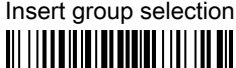
 of UPC-A.

Multiple-scan setting			Single-scan setting
Option bar code	Option	Alpha. entry	
Read  %2301M%	Disable	00*	 %2301D00% *
	Enable	01	 %2301D01%
Check digit verification  %2302M%	Disable	00*	 %2302D00% *
	1 digit (mod 10)	01	 %2302D01%
	Reserved	02	 %2302D02%
	Reserved	03	 %2302D03%
Check digit transmission  %2303M%	Disable	00*	 %2303D00% *
	Enable	01	 %2303D01%
Max. code length  %2304M%	00-99	00-99	
		00*	 %2304D00% *
Min. code length  %2305M%	00-99	00-99	
		00*	 %2305D00% *
Code ID setting  %2306M%	00-FF <sub>16</sub> (ASCII)	00-FF <sub>16</sub>	
		<O>*	 %2306H4F% *
Insert group selection  %2307M%	00-66	00-66	
		00*	 %2307D00% *
 %END%			

# UK/Plessey

Read:

Format

Data digits (variable)	2 check digits (optional)
------------------------	---------------------------

**Check digit verification:** The UK/Plessey has one or two optional check digits. The check digit 1 and check digit 2 will be calculated as the sum module 10 or 11 of the data digits.

**Check digit transmission:** By setting Enable, check digit will be transmitted.

**Max./Min. code length:** Refer to Max./Min. code length of Code 39.

**Code ID setting:** Refer to Code ID setting of UPC-A.

**Insertion group selection:** Refer to Insertion group selection of UPC-A.

Multiple-scan setting			Single-scan setting
Option bar code	Option	Alpha. entry	
Read  %2401M%	Disable	00*	 %2401D00% *
	Enable	01	 %2401D01%
Check digit verification  %2402M%	Disable	00	 %2402D00%
	Enable	01*	 %2402D01% *
Check digit transmission  %2403M%	Disable	00*	 %2403D00% *
	Enable	01	 %2403D01%
Max. code length  %2404M%	00-99	00-99	
		00*	 %2404D00% *
Min. code length  %2405M%	00-99	00-99	
		01*	 %2405D01% *
Code ID setting  %2406M%	00-FF <sub>16</sub> (ASCII)	00-FF <sub>16</sub>	
		<U>*	 %2406H55% *
Insert group selection  %2407M%	00-66	00-66	
		00*	 %2407D00% *





# China Post

Read:

Format

11 Data digits

**Max. /Min. code length:** Refer to **Max./Min. code length** of Code 39. The code length of China Post is 11.

**Code ID setting:** Refer to **Code ID setting** of UPC-A.

**Insertion group selection:** Refer to **Insertion group selection** of UPC-A.

Multiple-scan setting			Single-scan setting
Option bar code	Option	Alpha. entry	
Read  %2601M%	Disable	00	 %2601D00%
	Enable	01*	 %2601D01% *
Max. code length  %2604M%	00-99	00-99	
		11*	 %2604D11% *
Min. code length  %2605M%	00-99	00-99	
		11*	 %2605D11% *
Code ID setting  %2606M%	00-FF <sub>16</sub> (ASCII)	00-FF <sub>16</sub>	
		<T>*	 %2606H54% *
Insert group selection  %2607M%	00-66	00-66	
		00*	 %2607D00% *
 %END%			

## GS1 DataBar (GS1 DataBar Truncated)

GS1 DataBar Truncated is structured and encoded the same as the standard GS1 DataBar format, except its height is reduced to a 13 modules minimum; while GS1 DataBar should have a height greater than or equal to 33 modules.

**Read:**

Format

16 Data digits

**Code ID setting:** Refer to Code ID setting of UPC-A.

**Insertion group selection:** Refer to Insertion group selection of UPC-A.

**Conversion:**

**UCC/EAN 128-** Refer to Code ID transmission of String transmission, ]Cm will be identified as AIM ID.

**UPC-A or EAN-13-** Barcode beginning with a single zero as the first digit has the leading "010" stripped and the barcode reported as EAN-13. Barcode beginning with two or more zeros but not six zeros has the leading "0100" stripped and the barcode reported as UPC-A.

Multiple-scan setting			Single-scan setting
Option bar code	Option	Alpha. entry	
Read  %2701M%	Disable	00	 %2701D00%
	Enable	01*	 %2701D01% *
Code ID setting  %2702M%	00-FF <sub>16</sub> (ASCII)	00-FF <sub>16</sub>	
		<R >*	 %2702H52% *
Insert group selection  %2703M%	00-66	00-66	
		00*	 %2703D00% *
Conversion  %2704M%	None	00*	 %2704D00% *
	UCC/EAN 128	01	 %2704D01%
	UPC-A or EAN-13	02	 %2704D02%



# GS1 DataBar Limited

Read:



Format

16 Data digits

**Code ID setting:** Refer to Code ID setting of UPC-A.

**Insertion group selection:** Refer to Insertion group selection of UPC-A.

**Conversion:** Refer to Conversion of GS1 DataBar (GS1 DataBar Truncated).

Multiple-scan setting			Single-scan setting
Option bar code	Option	Alpha. entry	
Read  %2801M%	Disable	00	 %2801D00%
	Enable	01*	 %2801D01% *
Code ID setting  %2802M%	00-FF <sub>16</sub> (ASCII)	00-FF <sub>16</sub>	
		<R >*	 %2802H52% *
Insert group selection  %2803M%	00-66	00-66	
		00*	 %2803D00% *
Conversion  %2804M%	None	00*	 %2804D00% *
	UCC/EAN 128	01	 %2804D01%
	UPC-A or EAN-13	02	 %2804D02%
 %END%			

# GS1 DataBar Expanded

Read:

Format



Data characters (variable)

**Code ID setting:** Refer to Code ID setting of UPC-A.

**Insertion group selection:** Refer to Insertion group selection of UPC-A.

**Conversion:**

**UCC/EAN 128-** Refer to Code ID transmission of String transmission, ]Cm will be identified as AIM ID.

Multiple-scan setting			Single-scan setting
Option bar code	Option	Alpha. entry	
Read  %2901M%	Disable	00	 %2901D00%
	Enable	01*	 %2901D01% *
Max. code length  %2902M%	00-99	00-99	
		00*	 %2902D00% *
Min. code length  %2903M%	00-99	00-99	
		01*	 %2903D01% *
Code ID setting  %2904M%	00-FF <sub>16</sub> (ASCII)	00-FF <sub>16</sub>	
		<R >*	 %2904H52% *
Insert group selection  %2905M%	00-66	00-66	
		00*	 %2905D00% *
Conversion  %2906M%	None	00*	 %2906D00% *
	UCC/EAN 128	01	 %2906D01%

  
 %END%

## China Finance

*Note: This type of barcode is not Omni-directionally decodable. The encodable character set includes numeric 0 to 9. Among the symbol of 0 to 9, 0 and 2, 4 and 9, 5 and 8, 6 and 7, have the symmetrical pattern; the pattern of 1 and 3 is symmetrical.*

**Read:**

Format

10 Data digits

**Max./Min. code length:** Refer to Max./Min. code length of Code 39.















**Check digit verification:** The check digit is made as the sum module 10 of the numerical values of all data digits.





















**Leading character 5/6/7/8/9 converted to A/B/C/D/E:** By setting, leading character 5/6/7/8/9 can be converted to A/B/C/D/E.

**Leading character assignment:** By setting, only the barcode with the assigned leading character can be output.

**Code ID setting:** Refer to Code ID setting of UPC-A.

**Insertion group selection:** Refer to Insertion group selection of UPC-A.

Multiple-scan setting			Single-scan setting
Option bar code	Option	Alpha. entry	
Read  %3201M%	Disable	00	 %3201D00%
	Enable	01*	 %3201D01% *
Max. code length  %3202M%	00-99	00-99	
		10*	 %3202D10% *
Min. code length  %3203M%	00-99	00-99	
		10*	 %3203D10% *
Check digit verification  %3204M%	Disable	00*	 %3204D00% *
	Reserved	01	 %3204D01%
Leading character 5/6/7/8/9 converted to A/B/C/D/E  %3205M%	Disable	00	 %3205D00%
	Enable	01*	 %3205D01% *
	Only 5 converted to A	02	 %3205D02%
	Only 6 converted to B	03	 %3205D03%





Multiple-scan setting			Single-scan setting
Option bar code	Option	Alpha. entry	
	Only 7 converted to C	04	 %3205D04%
	Only 8 converted to D	05	 %3205D05%
	Only 9 converted to E	06	 %3205D06%
Leading character assignment  %3206M%	Disable	00	 %3206D00%
	Assigned to 0	01*	 %3206D01% *
	Assigned to 5(A)	02	 %3206D02%
	Assigned to 6(B)	03	 %3206D03%
	Assigned to 7(C)	04	 %3206D04%
	Assigned to 8(D)	05	 %3206D05%
	Assigned to 9(E)	06	 %3206D06%
	Assigned to 1	07	 %3206D07%
	Assigned to 2	08	 %3206D08%
	Assigned to 3	09	 %3206D09%
	Assigned to 4	10	 %3206D10%
Code ID setting  %3207M%	00-FF <sub>16</sub> (ASCII)	00-FF <sub>16</sub>	
		<Y>*	 %3207H59% *
Insert group selection  %3208M%	00-66	00-66	
		00*	 %3208D00% *
 %END%			

# PDF417

Read:

Format

Data characters (variable)





Multiple-scan setting			Single-scan setting
Option bar code	Option	Alpha. entry	
Read  %3001M%	Disable	00	 %3001D00%
	Enable	01*	 %3001D01% *
 %END%			

# MicroPDF417

Read:

Format

Data characters (variable)

Multiple-scan setting			Single-scan setting
Option bar code	Option	Alpha. entry	
Read  %3101M%	Disable	00	 %3101D00%
	Enable	01*	 %3101D01% *
 %END%			







# QR Code

Read:

Format

Data characters (variable)





Multiple-scan setting			Single-scan setting
Option bar code	Option	Alpha. entry	
Read  %4001M%	Disable	00	 %4001D00%
	Enable	01*	 %4001D01% *
 %END%			

# Data Matrix

Read:

Format

Data characters (variable)





Multiple-scan setting			Single-scan setting
Option bar code	Option	Alpha. entry	
Read  %4101M%	Disable	00	 %4101D00%
	Enable	01*	 %4101D01% *
 %END%			

# Han Xin Code

Read:

Format

Data characters (variable)





Multiple-scan setting			Single-scan setting
Option bar code	Option	Alpha. entry	
Read  %4201M%	Disable	00	 %4201D00%
	Enable	01*	 %4201D01% *
 %END%			

# Aztec Code

Read:

Format

Data characters (variable)

Multiple-scan setting			Single-scan setting
Option bar code	Option	Alpha. entry	
Read  %4301M%	Disable	00	 %4301D00%
	Enable	01*	 %4301D01% *
 %END%			

# G1-G6 & C1-C2 & FN1 substitution string setting

## Format of barcode data transmission

Prefix	Code name	Preamble	Code ID	Code length	Code data	Code ID	Postamble	Suffix
--------	-----------	----------	---------	-------------	-----------	---------	-----------	--------

**Suffix string setting:** The <enter> key is represented in different ASCII when it is applied by different OS. For a Windows/DOS OS, <enter> is represented as <CR><LF> (0x0D 0x0A); for an Apple MAC OS, <enter> is represented as <CR> (0x0D); for a Linux/Unix OS, <enter> is represented as <LF> (0x0A).

### Prefix/Suffix string setting: & Preamble/Postamble string setting:

They are appended to the data automatically when a barcode is decoded.

Example: Add a symbol of “\$” as a prefix for all symbols.

Steps:

- 1) Scan the option barcode of Prefix string setting.
- 2) Use the ASCII table to find the value of \$→24.
- 3) Scan 2 and 4 from the barcode on the last page.
- 4) Scan END barcode.

Scanning steps: Scan the following barcodes in order.

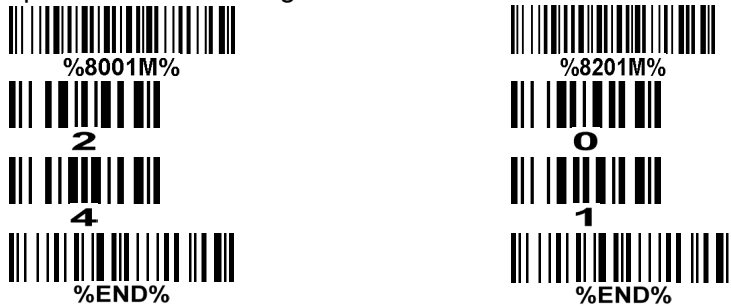

**Insert G1/G2/G3/G4 string setting:** The scanner offers 4 positions and 4 character strings to insert among the symbol.

Example: Set G1 string to be “AB”.

Original code data	“1 2 3 4 5 6”
Output code data	“1 2 A B 3 4 5 6”

Steps:

- 1) Scan the option barcode of Insert G1 string setting.
- 2) Use the ASCII table to find the value of A→41, B→42.
- 3) Scan 4, 1 and 4, 2 from the barcode on the last page.
- 4) Scan END barcode.
- 5) Refer to the chapter of G1-G4 string position & Code ID position.
- 6) Refer to the chapter of Hand-held scan & some global settings.

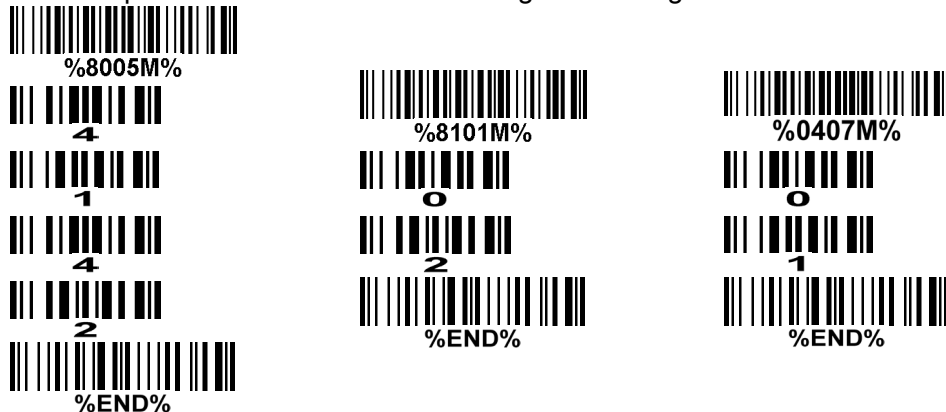

Testing barcode:



**FN1 substitution string setting:** The FN1 character (0x1D) in an UCC/EAN128 barcode, or a Code 128 barcode, or a GS1 DataBar barcode can be substituted with a defined string.

**Truncate leading G5 string setting:** By setting, a defined leading character or string can be truncated. Also a single character can be un-defined.

**Repeat of a G5 character setting:** While G5 is set as a single defined/un-defined character, G5 can also be set to be repeated. This setting is ignored when the truncate number is more than the barcode data characters. The option of “FF” for this setting is not active while the option of Truncate leading G5 string setting is “00”.

Example: Truncate all leading zeros for all symbols.

Original code data	“0 0 0 1 2 3 4 5 6”
Output code data	“1 2 3 4 5 6”

Steps: scan the following data in order.



Testing barcode:



**Truncate ending G6 string setting:** By setting, a defined ending character or string can be truncated. Also a single character can be un-defined.

**Repeat of a G6 character setting:** While G5 is set as a single defined/un-defined character, G6 can also be set to be repeated. This setting is ignored when the truncate number is more than the barcode data characters. The option of “FF” for this setting is not active while the option of Truncate ending G6 string setting is “00”.

**Single character C1/C2 replacement:** By setting, a defined character in the data string can be replaced by another defined character. The C1 and C2 replacement are applied simultaneously.

Example: Replace all the “A” character in a data string to be “B” character.

Original code data	“1 2 3 A 5 A”
Output code data	“1 2 3 B 5 B”

Steps: scan the following barcodes in order. The ASCII value for “A” is 41, and the ASCII value for “B” is 42.

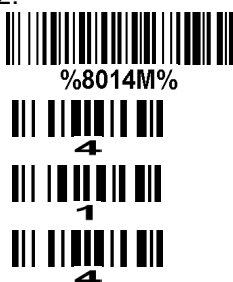



2





%END%

Testing barcode:



123A5A

Multiple-scan setting			Single-scan setting
Option bar code	Option	Alpha. entry	
Prefix string setting  %8001M%	0-22 characters	00-FF <sub>16</sub>	 %8001H00% *
	None	00*	
Suffix string setting  %8002M%	0-22 characters	00-FF <sub>16</sub>	
	<ENTER>	0D0A*	
Preamble string setting  %8003M%	0-22 characters	00-FF <sub>16</sub>	 %8003H00% *
	None	00*	
Postamble string setting  %8004M%	0-22 characters	00-FF <sub>16</sub>	 %8004H00% *
	None	00*	
Insert G1 string setting  %8005M%	0-22 characters	00-FF <sub>16</sub>	 %8005H00% *
	None	00*	
Insert G2 string setting  %8006M%	0-22 characters	00-FF <sub>16</sub>	 %8006H00% *
	None	00*	
Insert G3 string setting  %8007M%	0-22 characters	00-FF <sub>16</sub>	 %8007H00% *
	None	00*	
Insert G4 string setting  %8008M%	0-22 characters	00-FF <sub>16</sub>	 %8008H00% *
	None	00*	
FN1 substitution string setting  %8009M%	0-4 characters	00-FF <sub>16</sub>	 %8009H20% *
	<SP>	20*	

Multiple-scan setting			Single-scan setting
Option bar code	Option	Alpha. entry	
Truncate leading G5 string setting  %8010M%	A un-defined character	00	 %8010H00%
	1-22 defined characters	01-7F <sub>16</sub>	
	<0>	30*	 %8010H30% *
Repeat of a G5 character setting  %8011M%	Once	01*	 %8011H01% *
	Defined times	01-22	
	Un-defined times (All)	FF	 %8011HFF%
Truncate ending G6 string setting  %8012M%	A un-defined character	00	 %8012H00%
	1-22 defined characters	01-7F <sub>16</sub>	
	<0>	30*	 %8012H30% *
Repeat of a G6 character setting  %8013M%	Once	01*	 %8013H01% *
	Defined times	01-22	
	Un-defined times (All)	FF	 %8013HFF%
Single character C1 replacement  %8014M%	<0000>	0000*	
		0000-FFFF <sub>16</sub>	
Single character C2 replacement  %8015M%	<0000>	0000*	
		0000-FFFF <sub>16</sub>	
 %END%			













# G1-G4 string position & Code ID position

## Format of barcode data transmission

Prefix	Code name	Preamble	Code ID	Code length	Code data	Code ID	Postamble	Suffix
--------	-----------	----------	---------	-------------	-----------	---------	-----------	--------

**Insert G1/G2/G3/G4 string position:** The scanner offers 4 positions to insert strings among the symbol. In case of the insertion position is greater than the length of the symbol, the insertion of string is not effective.

**Code ID position:** It is allowed to select different positions of code ID placement.

Multiple-scan setting			Single-scan setting
Option bar code	Option	Alpha. entry	
Insert G1 string position  %8101M%	00-99	00-99	 %8101D00% *
		00*	
Insert G2 string position  %8102M%	00-99	00-99	 %8102D00% *
		00*	
Insert G3 string position  %8103M%	00-99	00-99	 %8103D00% *
		00*	
Insert G4 string position  %8104M%	00-99	00-99	 %8104D00% *
		00*	
Code ID position  %8105M%	Before code data	00*	 %8105D00% *
	After code data	01	
 %END%			

## String transmission

*Note: The information in this chapter is closely related to the chapter of String setting.*

### Format of barcode data transmission

Prefix	Code name	Preamble	Code ID	Code length	Code data	Code ID	Postamble	Suffix
--------	-----------	----------	---------	-------------	-----------	---------	-----------	--------

**Prefix transmission:** By setting Enable, prefix will be appended before the data transmitted.

**Suffix transmission:** By setting Enable, suffix will be appended after the data is transmitted.

**Code name transmission:** By setting Enable, code name will be transmitted before code data.

**Preamble transmission:** By setting Enable, preamble will be appended before the data transmitted.

**Postamble transmission:** By setting Enable, postamble will be appended after the data is transmitted.

**Code ID transmission:** Code ID can be transmitted in the format of either Proprietary ID or AIM ID. Refer to the chapter of Default setting for each barcode.

**Code length transmission:** The length of code data string can be transmitted before the code data when Enable is selected. The length is represented by a number with two digits.























**Case conversion:** The characters within code data or the whole output string can be set in either upper case or lower case.

**FN1 substitution transmission:** The scanner supports a FN1 substitution feature for keyboard wedge, USB and RS-232 interface. The replacement string of FN1 can be chosen by user (see chapter of G1-G6 & FN1 substitution string setting).

**All-non-printable-character string transmission with string setting:** By setting enable, all string settings, e.g. Preamble transmission or Insert G1 string setting, are active for an all-non-printable-character string. Here a non-printable character means a character with ASCII value between 0x00 to 0x1F.

**Transmit the first N data characters only:** The scanner supports to only transmit the first N data characters of a barcode. The number of N can be set as a digit between 1 and 99.

**Transmit the last N data characters only:** The scanner supports to only transmit the last N data characters of a barcode. The number of N can be set as a digit between 1 and 99.

Multiple-scan setting			Single-scan setting
Option bar code	Option	Alpha. entry	
Prefix transmission  %8201M%	Disable	00*	 %8201D00% *
	Enable	01	 %8201D01%
Suffix transmission  %8202M%	Disable	00	 %8202D00%
	Enable	01*	 %8202D01% *
Code name transmission  %8203M%	Disable	00*	 %8203D00% *
	Enable	01	 %8203D01%
Preamble transmission  %8204M%	Disable	00*	 %8204D00% *
	Enable	01	 %8204D01%
Postamble transmission  %8205M%	Disable	00*	 %8205D00% *
	Enable	01	 %8205D01%
Code ID transmission  %8206M%	Disable	00*	 %8206D00% *
	Proprietary ID	01	 %8206D01%
	AIM ID	02	 %8206D02%
Code length transmission  %8207M%	Disable	00*	 %8207D00% *
	Enable	01	 %8207D01%
Case conversion  %8208M%	Disable	00*	 %8208D00% *
	Upper (data only)	01	 %8208D01%
	Lower (data only)	02	 %8208D02%
	Upper (whole string)	03	 %8208D03%
	Lower (whole string)	04	 %8208D04%
FN1 substitution transmission	Disable	00*	 %8209D00% *

Multiple-scan setting			Single-scan setting
Option bar code	Option	Alpha. entry	
 %8209M%	Keyboard wedge/USB	01	 %8209D01%
	RS-232	02	 %8209D02%
	Keyboard wedge / USB / RS-232	03	 %8209D03%
All-non-printable-character string transmission with string setting  %8210M%	Disable	00*	 %8210D00% *
	Enable	01	 %8210D01%
Transmit the first N data characters only  %8211M%	All	99*	 %8211D99% *
	01-99		
Transmit the last N data characters only  %8212M%	All	99*	 %8212D99% *
	01-99		
 %END%			

# Test Chart

UPC-A



UPC-E



EAN-8



EAN-13



Code 39



Code 32



Code 128



Interleaved 2 of 5



Industrial 2 of 5

(Default setting: Read disable)



Matrix 2 of 5



Code 93



Test Chart (Continued)

UCC/EAN 128



Code 11

(Default setting: Read disable)



MSI/Plessey

(Default setting: Read disable)



UK/Plessey



ISBN/ISSN



China Post



GS1 DataBar (GS1 DataBar Truncated)



GS1 DataBar Limited



GS1 DataBar Expanded



Test Chart (Continued)

PDF417



12=890ab+%xyz

MicroPDF417



23+-mdo

QR code



1234567890ABCD-+)&\*%^\#@#\$!XYZ

Data Matrix

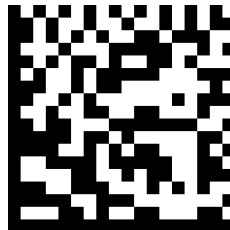

123890abc-+&\*%^\!mdo

## Maintenance

Cleaning the exit window is the only maintenance required. A dirty window may affect scanning accuracy.

1. Do not allow any abrasive material to touch the window.
2. Remove any dirt particles with a damp cloth.
3. Wipe the window using a tissue moistened with water.
4. Do not spray water or other cleaning liquids directly into the window.
5. Use a piece of soft and dry cloth when cleaning the scanner.



## Assembling the stand

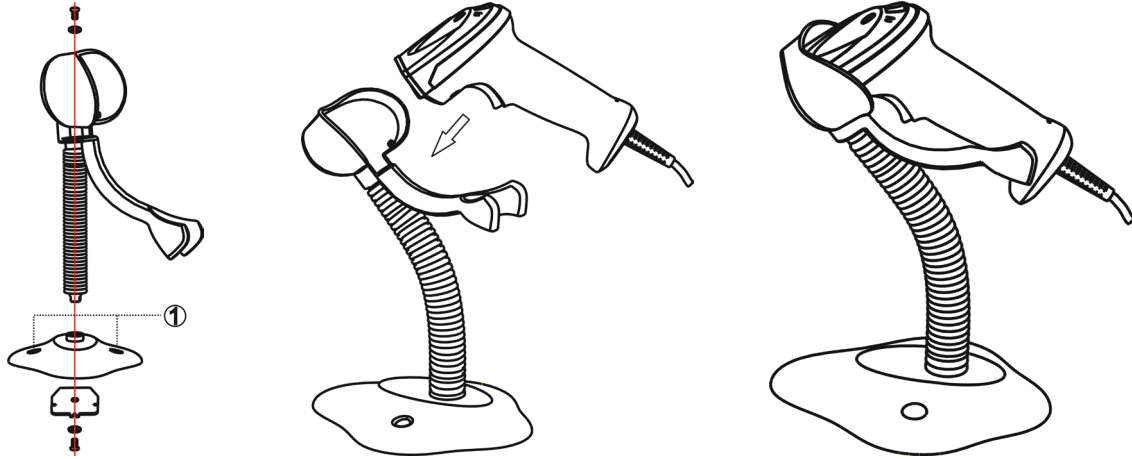

1. See the figure above, tighten the screws.
2. Bend the neck to the desired position for scanning.
3. Screw mounting: Screw one #10 wood screw into each screw-mount-hole until the base of the stand is secured.
4. Tape mounting: ①Peel the paper liner off one side of each piece of tape and place the sticky surface over each of the three rectangular tape holders. ②Peel the paper liner off the exposed sides of each piece of tape and press the stand on a flat surface until it is secure.

## ASCII Table

		for keyboard wedge		for RS-232	
H L	0	1	0	1	
0	Null		NUL	DLE	
1	Up	F1	SOH	DC1	
2	Down	F2	STX	DC2	
3	Left	F3	ETX	DC3	
4	Right	F4	EOT	DC4	
5	PgUp	F5	ENQ	NAK	
6	PgDn	F6	ACK	SYN	
7		F7	BEL	ETB	
8	Bs	F8	BS	CAN	
9	Tab	F9	HT	EM	
A		F10	LF	SUB	
B	Home	Esc	VT	ESC	
C	End	F11	FF	FS	
D	Enter	F12	CR	GS	
E	Insert	Ctrl+	SO	RS	
F	Delete	Alt+	SI	US	

Notes: The 2nd and the 3rd columns above are used for keyboard wedge only.

H L	2	3	4	5	6	7
0	SP	0	@	P	`	p
1	!	1	A	Q	a	q
2	“	2	B	R	b	r
3	#	3	C	S	c	s
4	\$	4	D	T	d	t
5	%	5	E	U	e	u
6	&	6	F	V	f	v
7	‘	7	G	W	g	w
8	(	8	H	X	h	x
9	)	9	I	Y	i	y
A	*	:	J	Z	j	z
B	+	;	K	[	k	{
C	,	<	L	\	l	
D	-	=	M	]	m	}
E	.	>	N	^	n	~
F	/	?	O	_	o	DEL

Example: ASCII “A” = “41”.

## Barcode representing non-printable character

Notes to make the following barcode:

1. According to different barcode printing software, the method of printing following barcode is different.
2. If using CODESOFT software, firstly read the information through “Help→Index→Code128→Special input syntax”. Also refer to ASCII table. For example, if we wish to make “F1” barcode, select “code128”, then select “CODE A” type, and input “{DOC1}” as data.



**Up** ↑



**Down** ↓



**Left** ←



**Right** →



**Page Up**



**Page Down**



**Backspace**



**Tab**



**Home**



**End**



**Enter**



**Insert**



**Delete**



**F1**



**F2**



**F3**



**F4**



**F5**



**F6**



**F7**



**F8**



**F9**



**F10**



**Esc**



**F11**



**F12**

## Return default parameters & others



**%%%DEF**

**WARNING: Default value initialization**

If you wish to return the scanner to all the factory default settings, scan the barcode above.



**%%%VER**

**Firmware version list**

If you wish to display the firmware version, scan the barcode above.

# Configuration alphanumeric entry barcode

